

Vurulma qaydası

AMK

DEKORATİV ÖRTÜKLƏR

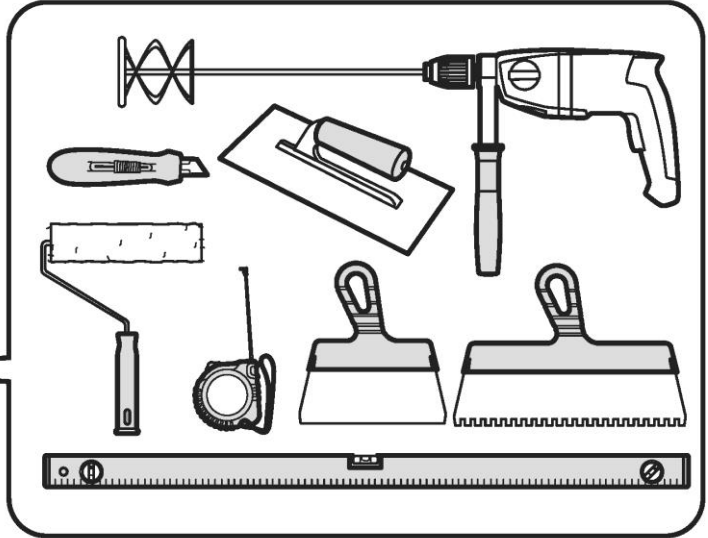

1 Səthi hazırlayıb, qruntlamaq (binder)

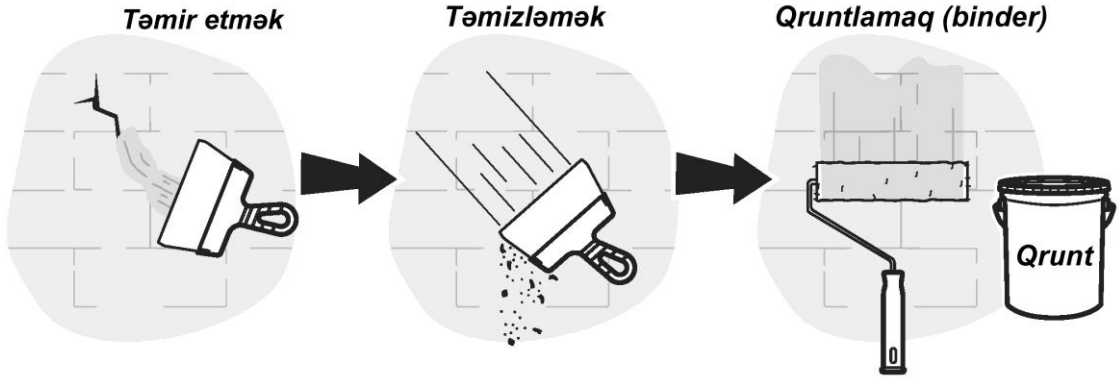

2 Ölçüləri və başlanğıc nöqtələri müəyyənləşdirmək

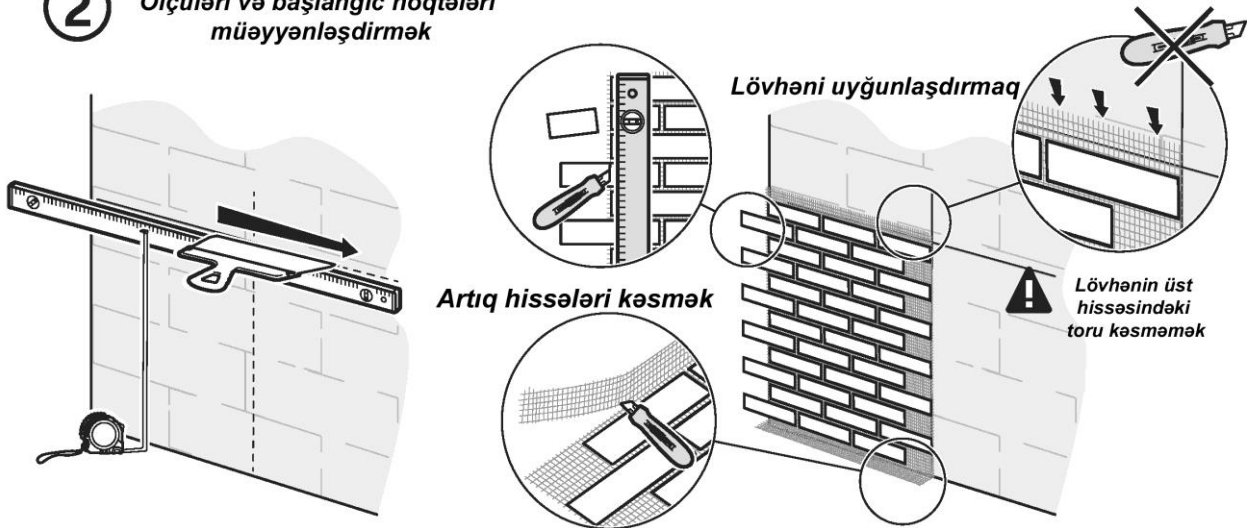

3 Yapıştırıcı məcununu hazırlamaq

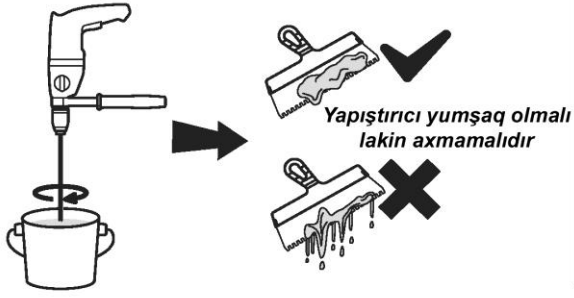

4 Yapıştırıcını divar səthinə yaxmaq

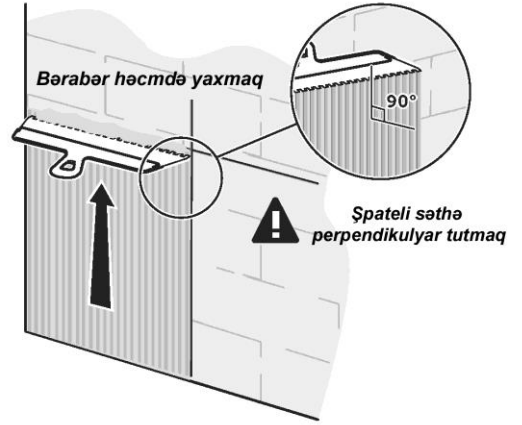

5 Lövhəni divar səthinə yapışdırmaq

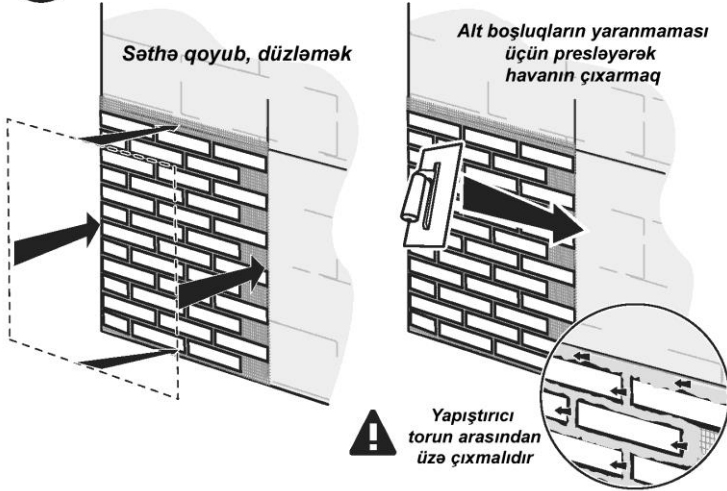

7 Dəzrləri yapıştırıcı ilə doldurmaq

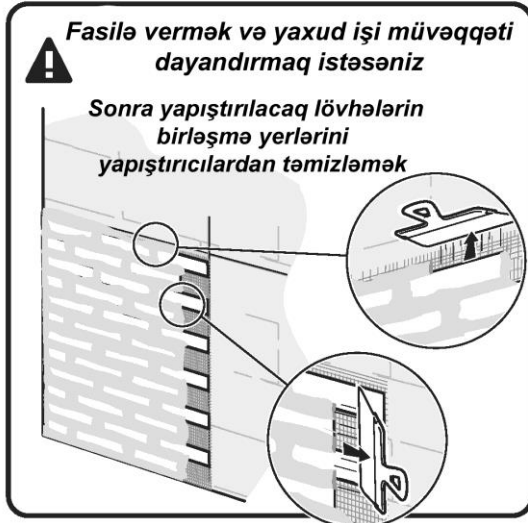
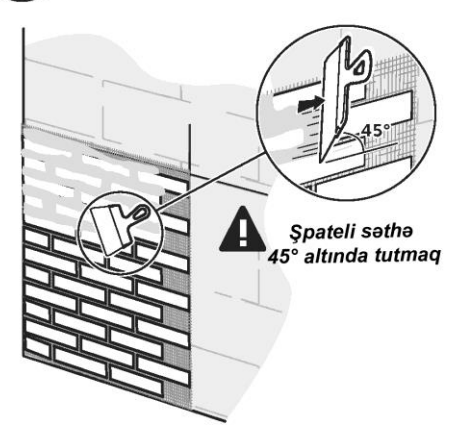

8 Yapıştırıcı tam quruduqdan sonra qoruyucu qatları çıxarmaq

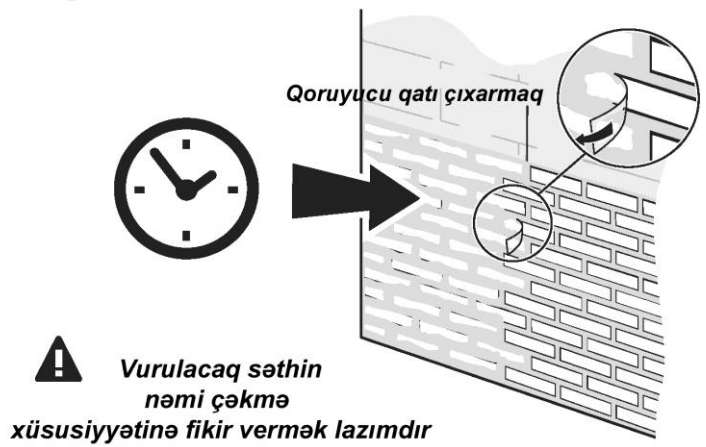

amk-fasad.az daxil olun!



Təlim videolarına baxın

AMK Fasad Üznlükləri

Bakı, Məmməd Araz 42
+994 51 207 94 07
info@amk-fasad.az